

INSTRUCTION

GREASE LUBRICATOR

SKR- 55EX MODEL No.881190



WARNING

Prior to operating this pump, be sure to read this operation manual for safety. After reading the manual, please keep it at hand any time for your quick reference.

YAMADA CORPORATION

- Preface

Thank you very much for purchasing Yamada Pump. This machine is a portable type lubricator that is indispensable for grease lubrication for machines and vehicles. This lubricator cannot be used for oil lubrication. The applicable grease is limited to a type of NLGI No.0 or less in the normal operating conditions. If the lubricator is used in an extremely cold or low-temperature environment, the discharge volume will be remarkably lowered. Silicone grease is not applicable.

- For Safe Operation

This document describes the items that are important for the user to operate this product safely, correctly, and efficiently. Before operating this product, read this manual thoroughly, in particular, "Warnings and Cautions" at the beginning of this manual, with a good understanding of its contents. Keep this manual carefully in an easy-to-access place so that the user may refer to it whenever necessary.

- Warnings and Cautions

To use this product safely, be sure to observe the contents of the following description. In this manual, warnings and cautions are indicated by using symbols. These symbols are intended to prevent death or serious injury that may be caused to the operator or those who are around the product and damage that may be caused to the articles that are around the product, as well as to use the product safely and correctly. Each symbol is indicated and has a meaning as shown below. Read the description with a good understanding of its contents.



WARNING : This indicates the existence of potential hazard which, if not avoided, will result in death or serious injury.



CAUTION : This indicates the existence of potential hazard which, if not avoided, may result in bodily injury or in physical damage.

To indicate the contents of danger and damage, the following symbols are used together with the above indications.



This symbol indicates an act that is prohibited (prohibition). The concrete contents of prohibition are indicated by the side of the indication.



















This symbol indicates the contents that must be observed. The concrete contents of observance are indicated by the side of the indication.



- Precautions on Use

The following warnings and cautions are very important. Be sure to observe them.

WARNING

-  - Keep your face away from the exhaust and discharge ports. Material may suddenly come out. There is a possibility of losing eyesight if it strikes eyes.
-  - Keep your face and hands away from the outlet when handling the check valve. Air-containing material may suddenly come out. There is a possibility of losing eyesight and injuring the hand.
-  - Do not aim exhalation part of this product at any person. Residual pressure may be left inside the gun even when the pump is not in operation. There is a possibility of losing eyesight if it strikes eyes.
-  - Gasoline is a high volatile fuel. Do not use it to clean the pump in any case, otherwise ignition or explosion may be caused.
-  - Modification of this pump may lead to death, bodily injury, or a failure. Do not modify it in any case because it involves a risk.
-  - The operator and maintenance engineer should read the operation manual thoroughly before operating this product and performing maintenance in respect of this product.
-  - Always wear proper safety equipments (facemask, ear plugs, and safety shoes, etc.) when installing, operating, and disassembling this product.
-  - Lock caster's stopper during and after the work, so that this product should not move unexpectedly. Also, do not use or leave this product in a slope or any unstable locations. This product moves freely when the caster is not locked and the damage only accident and the facilities pollution, etc. might occur. Such a secondary disaster becomes a responsibility on the user side.
-  - Make ground connection when working with flammable material or in explosive atmosphere. Rapid pumping of material can result in static electrical charge. Also, be sure to provide proper ventilation where a flammable atmosphere may exist.
-  - Execute the daily checkup.
-  - Use this product according to the product specification.
-  - Attach a valve (for stop in emergency) or regulator to the air supply pipe to keep supply air pressure under 0.7MPa.
-  - Be careful not to drop the cabinet when lifting it up to replace a pail. Catching a falling cabinet may cause hand injury by its edge.
-  - Turn off the air supply to stop pump operation when removing the pump from a pail. Being caught in a shovel, the lowest part of the pump, can cause hand injury and malfunction of the pump.
-  - Discontinue it when you feel a hazard or abnormality during the work. And correspond according to the troubleshooting.
-  - Stop pump operation immediately when a drum becomes empty. Running the pump dry will cause excessive vibration, resulting in reduction of pump life and damage to other equipment.
-  - Be very careful not to drop the grease gun. It may become damaged, resulting in leakage and malfunction.

WARNING

-  - Before maintenance operation, be sure to stop air from being supplied to the pump, and release the internal pressure (both air and material) of the pump. There is danger such as spouting of the material when the maintenance work is done with air supplied.
-  - Do not discharge material directly onto the ground. Dispose of harmful materials according to the requirements specified in SDS or local regulations. Also, dispose of this product according to the local regulations after removing residual material from inside this product. (Please contact industrial waste disposal service.)

CAUTION











-  - Keep hands and fingers away from this product during operation to avoid injury from moving parts.
-  - Use this product for the material suitable for the specification. Parts may be corroded and material leak from the damaged parts can lead to environmental pollution. Also, follow handling notes (SDS) of the manufacturer about the handling of the material used.
-  - Take protective measures against rainwater and dust. It is likely to lead to the pollution of the material.
-  - Watch your step around this product to avoid tripping over the base and casters.
-  - Be careful about your hands when mounting/dismounting the cabinet or installing a pail. The edges of the cabinet and pail may cause hand injury. Also, be careful about your posture when moving the pump or lifting the cabinet to avoid back injury.
-  - Material remaining inside or on the surface of the pump may spill out by inserting or removing the pump into/from a pail. Be very careful not to get your clothing dirty.
-  - Do not touch the surfaces of the pump and the hose when pumping high-temperature material. Risk of burns exists.
-  - Be careful when handling the grease gun. Avoid finger injury from being caught between the lever and gun. The finger might be injured.
-  - Stop the air supply source after the end of work when not using this pump for a long time such as nighntimes and holidays. Also, open the valve of the exhalation port and liberate pressure in the pump and the hose. There is a possibility of polluting facilities because of the damage of the hose and the leakage of the valve. Such a secondary disaster becomes a responsibility on the user side.
-  - Do not lift the product with the pail installed. It may cause the leak of the material and the damage of the parts.

Table of Contents

| | |
|--|----|
| - Preface | |
| - For Safe Operation | |
| - Warnings and Cautions | |
| - Precautions on Use | |
| - Table of Contents | |
| 1. Name of Parts | |
| 1.1 Name of parts | 1 |
| 1.2 Contents of package | 1 |
| 2. Preparations before Operation | |
| 2.1 Function of the Air Motor | 2 |
| 2.2 Function of the Lower Pump | 2 |
| 3. Preparations before Operation | 3 |
| 4. How to Operate the Machine | 4 |
| 5. Maintenance and Inspection | |
| 5.1 Troubleshooting and corrective measures | 5 |
| 5.2 Maintenance and inspection | 5 |
| 5.3 Disassembly and assembly | 6 |
| 6. Parts Disassembly Drawing and Parts List | |
| 6.1 881190 SKR-55EX | 7 |
| 6.2 852498 Pump assembly | 7 |
| 6.3 802630 Air motor | 8 |
| 6.4 851985 Grease gun | 9 |
| 7. Specification | 10 |
| 8. Limited Warranty | 11 |

1. Names of Parts

1.1 Names of parts

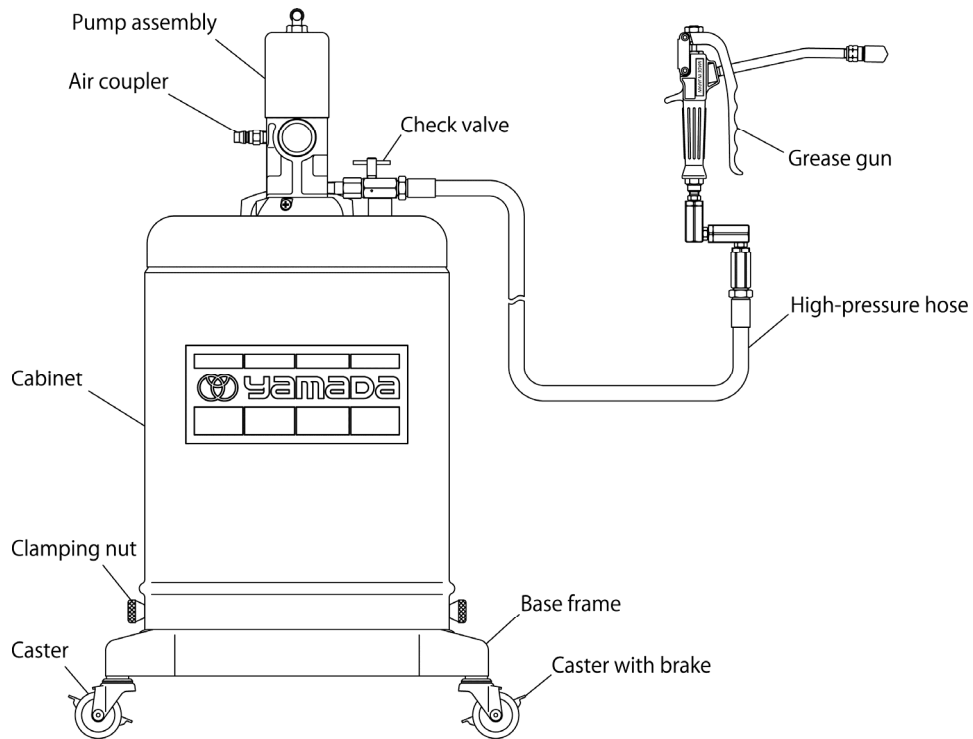

1.2 Contents of package

The main devices and the accessories are packed in different cases.

Open the top part of the corrugated fiberboard case and check if the devices is not damaged and if accessories are all contained in the package.

2. Principle of Operation

The YAMADA Air-powered Pump is a reciprocating type pump that is driven by compressed air. This pump consists of an air motor to drive the pump and a lower pump to draw up the liquid material as shown in the figure.

2.1 Function of the Air Motor

- 1) In the status shown in the figure at right, the air piston reaches the upper limit and is now about to go down.
- 2) The compressed air fed from the air supply port is applied to the chamber A through the air passage tube from the path provided in the lower part of the slide valve. The air pressure of the chamber B is discharged out through the slide valve.
- 3) As a result, the air piston starts to go down.
- 4) When the air piston collides with the trip shoe, the slide valve is momentarily tripped downward by the function of the trip mechanism.
- 5) As a result, the air supply is conducted to the chamber B and the chamber A is conducted to the exhaust port, so that the air piston is changed to go up.
- 6) Thus, the air motor continues its reciprocating motion automatically as long as the supply air is fed to it.

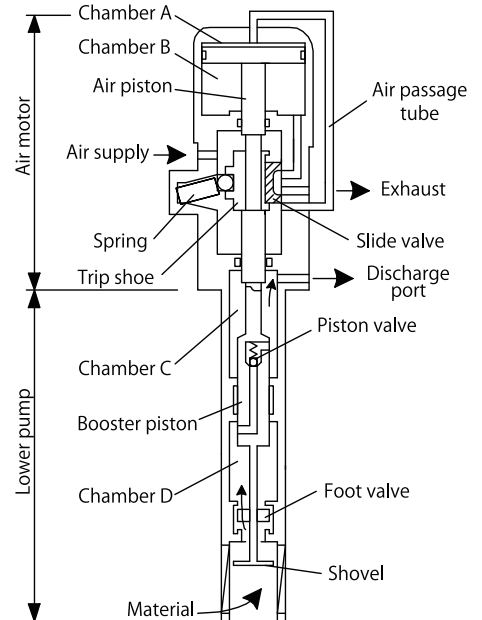

2.2 Function of the Lower Pump

- 1) The lower pump integrated with the air motor traces the reciprocating motion of the air motor.
- 2) The shovel performs mixing so that grease may be easily sucked into the pump, and squeezes it into the foot valve.
- 3) Because the chamber D has a sectional area difference of the booster piston, it sucks the grease from the shovel at the ascending motion. At the descending motion, the foot valve is closed, so that the grease of the chamber D is fed out to the chamber C.
- 4) Because the chamber C leads to the discharge port, the grease is intermittently discharged to the delivery side.
- 5) This reciprocating motion is automatically continued until the delivery side is closed and the material compressive force of the chamber C and chamber D is completely balanced with the pressure of the air motor.

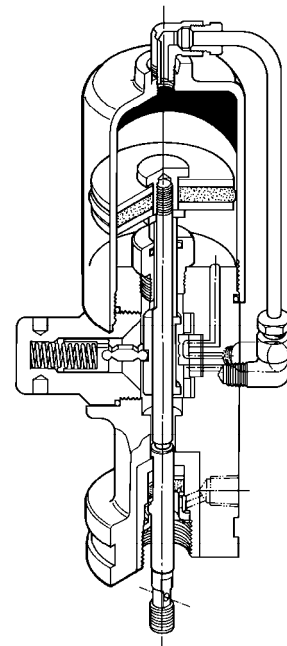

3. Preparations before Operation

- 1) First loosen the pan-head screw and take out the pump from the cabinet. Remove the rubber cap at the bottom of the pump assembly, insert the pump into the cabinet, and fix it with a pan-head screw.
<Assembly of Equipment> indicated on the top surface of the corrugated fiberboard case. (Fig. 1)
- 2) Loosen the two clamping nuts at the bottom of the cabinet (turn them counterclockwise), and remove the cabinet from the base frame. (Fig. 2)
- 3) Place a pail in the middle of the base frame and install the cabinet as it was. Tighten the clamping nuts on both sides equally.
- 4) Connect the attached high-pressure hose and grease gun to the discharge port of the pump.
- 5) When the air coupler is connected to the pump, the pump and hose will be filled with grease. After that, the pump operation will stop.
- 6) The first applied grease includes the internal air of the pump. This is not a good condition. Obtain a perfect condition by the next operation.
First open the check valve and operate the pump until grease is discharged from a small hole under the check valve. (Fig. 3)
At this time, spread paper so that grease may not come into touch with the hand, and dispose of the discharged grease.

<NOTE>

- The grease in which air is mixed is cloudy in white.

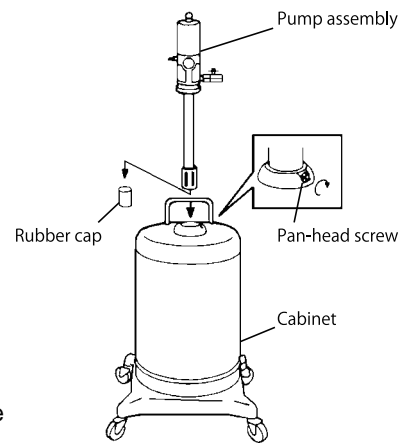

Fig. 1

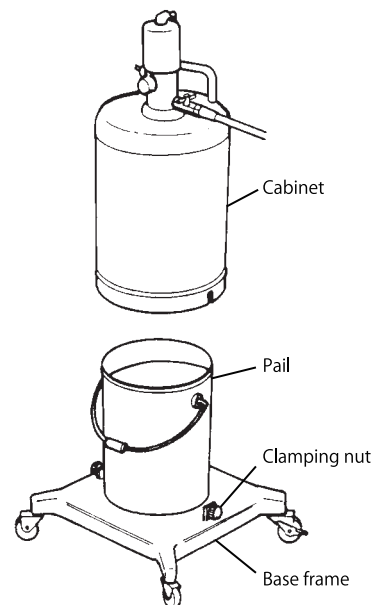

Fig. 2

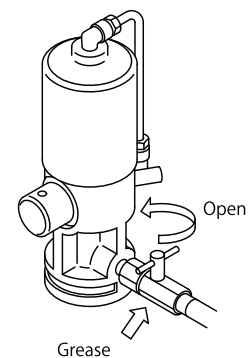

Fig. 3

4. How to Operate the Machine

CAUTION



- Do not operate the gun lever with the discharge port facing to another person during machine operation. A direct hit against the human body may result in an accident such as skin damage.



- The maximum operating air pressure of this machine is 0.7 MPa. Using the machine over this pressure may result in a bodily accident or physical accident due to damage. Do not operate the machine over 0.7 MPa. If the air line is 0.7 MPa, reduce the air line to 0.7 MPa or less by using the air regulator.



- During machine operation or after completion of movement, be sure to lock the caster brake for locking. (Fig. 4)



- Regarding a secondary accident such as hose damage that may be caused without shutting off of the air supplied to the hose or installation contamination due to a leak from the valve or gun after completion of the work or at night, the responsibility rests with the user side.

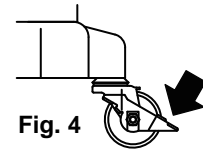

Fig. 4

- 1) Wipe the grease nipple to be used for greasing completely. After that, push the hydro chuck of the high-pressure grease gun against the nipple to perform chucking as vertically as possible. (Fig. 5)
- 2) Pull the lever of the high-pressure grease gun to supply grease. The pump is automatically operated to supply grease. When grease is normally injected, old grease will be squeezed out from the groove or clearance bear the nipple.
- 3) After completion of grease supply, release the gun lever. The grease supply will be stopped and the pump will also be stopped automatically.
- 4) Remove the hydro chuck of the grease gun. Since pressure is applied to the hydro chuck, the head of the nipple may be broken if it is suddenly pulled. Incline the hydro chuck to bleed the internal pressure and loosen the claw bite, and the chuck can be easily removed. (Fig. 6)
- 5) After completion of greasing work or when the pump is not used for a long time, be sure to shut off the supply air and bleed the internal air of the pump, grease gun and hose by operating the gun lever.
- 6) If the pump is suddenly started, it may be due to non-existence of grease in the pail or a cavity produced. Stop the greasing work and make a check. If the grease is used up, replace the pail.

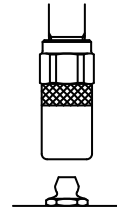

Fig. 5



Fig. 6

5. Maintenance and Inspection

5.1 Troubleshooting and corrective measures

| Symptom | Cause | Contents of inspection and corrective measure. |
|--|--|---|
| The pump cannot be operated. | Check if the supply air pressure is normal. ↓ (Operate the pump with the discharge-side hose removed.) → If the pump is operated, the outlet valve of the hose is clogged. → If the pump is not operated, the pump is defective. | Adjust the supply air pressure between 0.2 and 0.7 MPa. Ask the dealer to repair it. |
| | Check if grease is in the pail. | Supply grease. |
| The pump is operated but no grease comes out. | Check if a cavity is produced in the suction tube. | Gather grease toward the middle. |
| | The lower pump is defective. | Ask the dealer to repair it. |
| Grease comes out but the flow rate is low. | Check if the supply air pressure is lowered. | Check the supply air pressure. |
| | The lower pump is defective. | Ask the dealer to repair it. |
| The pump is continuously operated without stop. (even if the outlet valve is closed) | Check the discharge-side hose and connecting section for leakage. | Check the hose and the connecting section. |
| | Check if the grease in the pail has been used up. | Supply or replace grease. |
| | The lower pump is defective. | Ask the dealer to repair it. |

5.2 Maintenance and inspection

■Oiling

For lubrication of the pump, perform oiling with a lubricant once every 10 days. Apply the lubricant as follows.

- 1) Remove the air regulator.
- 2) Inject several drops (approx. 0.5ml) of lubricant to the air supply port as shown in the figure at right. (Fig. 7)
Use turbine oil first class ISO(VG-32) as the lubricant.

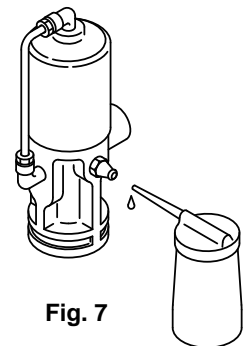





Fig. 7

■Inspection

- The hose is a consumable part. Check it periodically. If any blemish or leakage is found, replace the hose little earlier.
- The packing and slide portion parts of the pump are worn away. Check and replace them once a year.

5.3 Disassembly and assembly

⚠ WARNING

-  - Gasoline is a high-volatility material. Do not use gasoline to clean the pump in any case, otherwise it may cause ignition or explosion.
-  - When washing parts, do not use such a liquid as corrodes aluminum, copper alloy, iron, etc.
-  - When disassembling and checking the pump, be sure to stop the supply air and open the outlet valve to release the internal pressure of the pump beforehand.
-  - Some types of grease may contain a carcinogenic material. Read the cautions for handling grease given by the grease maker carefully when handling the grease.

- ※ When the pump operation becomes defective or stops, do not disassemble the pump thoughtlessly but judge the condition carefully by referring to the item pertaining to <Troubleshooting and Corrective Measures>.
- ※ If the foot valve is clogged with dust or the like, perform disassembling, washing and inspection according to the following procedure.
- ※ For disassembling parts other than the foot valve and the air motor, ask the dealer for disassembly

[Disassembling the foot valve]

- 1) Bleed the internal pressure of the pump and hose and remove the air chuck and high-pressure hose from the pump.
- 2) Unscrew the pan-head screw of the body supporter that fixes the pump. Pull out the pump from above. (Fig. 8)
- 3) Fix the main body of the pump on the vise and set a spanner on the valve adapter. Set a pipe wrench on the tube and unscrew the tube.
- 4) Pull out the split pin that fixes the plate and unscrew the nut. The plate can be removed. (Fig.9)
- 5) Set a spanner on the valve adapter and unscrew it. The valve seat, foot valve and washer can be taken out from the suction tube.
- 6) If they are hard to take out, set a pipe wrench on the knurling of the suction tube and unscrew the suction tube.
- 7) Pull apart the suction tube a little, and the union connecting between the air motor and the rod becomes visible. Pull out the pin and unscrew it for removal. (Fig.10)
- 8) The air motor is separated from the lower pump. The valve seat, foot valve and washer can be taken out from the inside of the suction tube. (Fig.11)
- 9) Wash and check each part. If any blemish or wear is found, replace the part with a new one. In particular, pay attention to filter clogging in valve adapter.
- 10) For assembling, reverse the disassembling procedure. At this time, perform inspection taking care about the directions of the valve seat and foot valve.

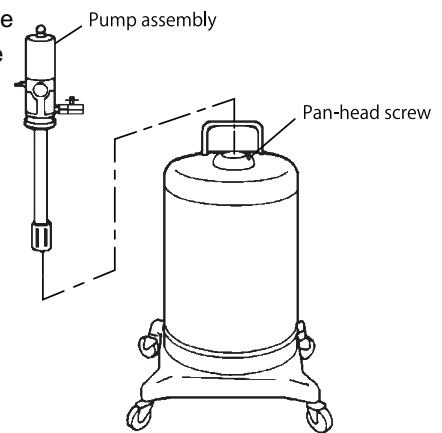

Fig. 8

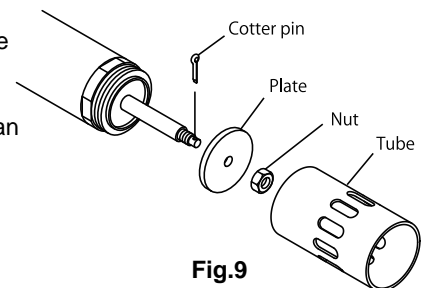

Fig.9

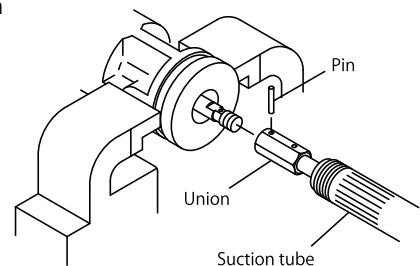

Fig.10

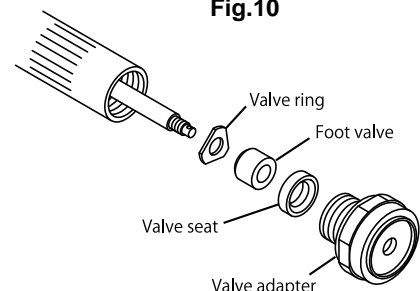
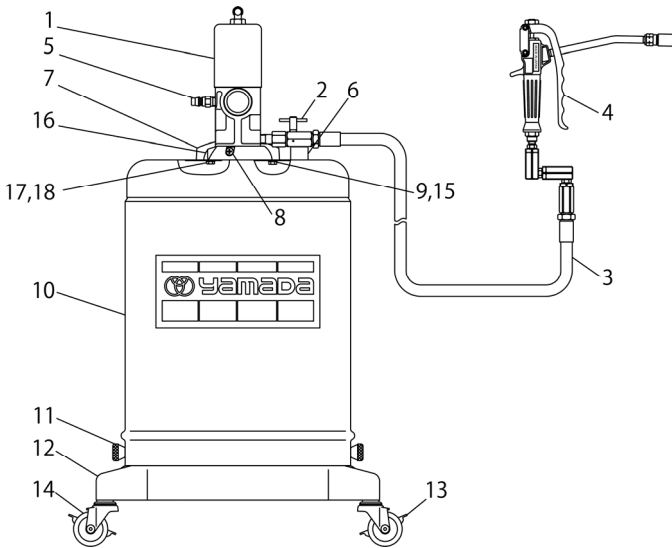

Fig.11

6. Parts Disassembly Drawing and Parts List

6.1 881190 SKR-55EX



Parts List

| NO. | PARTS NO. | DESCRIPTION | QTY |
|-----|-----------|-----------------------|-----|
| 1 | 852498 | Pump assembly | 1 |
| 2 | 800766 | Check valve | 1 |
| 3 | 695034 | High-pressure hose | 1 |
| 4 | 851985 | Grease gun | 1 |
| 5 | 680743 | Air coupler | 1 |
| 6 | 770331 | Gun holder | 1 |
| 7 | 686880 | Handle | 1 |
| 8 | 602296 | Pan-head screw | 1 |
| 9 | 631418 | Spring lock washer | 2 |
| 10 | 833170 | Cabinet | 1 |
| 11 | 704570 | Clamping nut | 2 |
| 12 | 831098 | Base frame | 1 |
| 13 | 681767 | Caster (with brake) | 2 |
| 14 | 680136 | Caster | 2 |
| 15 | 611095 | Bolt | 2 |
| 16 | 709000 | Pump holder | 1 |
| 17 | 686881 | Tapping screw | 3 |
| 18 | 681770 | Conical Spring washer | 3 |

6.2 852498 Pump assembly

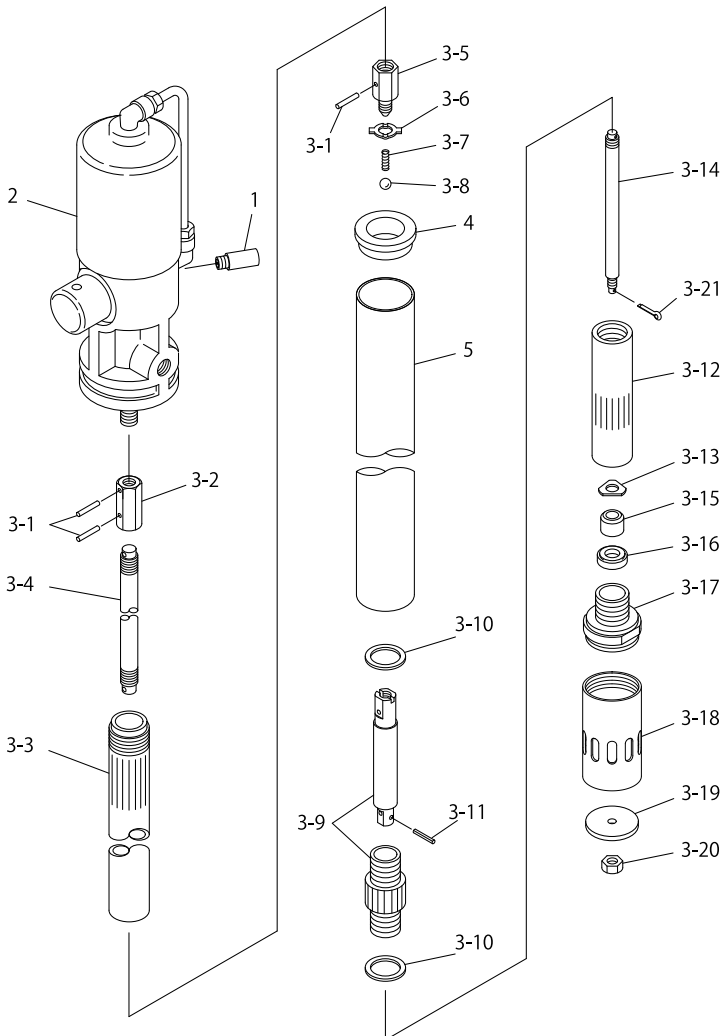

Parts List

| NO. | PARTS NO. | DESCRIPTION | QTY |
|------|-----------|------------------------|-----|
| 1 | 681170 | Silencer | 1 |
| 2 | 802630 | Air motor | 1 |
| 3 | 803358 | Lower pump | — |
| 3-1 | 702971 | Pin | 3 |
| 3-2 | 706091 | Union | 1 |
| 3-3 | 702985 | Suction tube | 1 |
| 3-4 | 702986 | Rod | 1 |
| 3-5 | 702975 | Union | 1 |
| 3-6 | 702974 | Stop washer | 1 |
| 3-7 | 702976 | Spring | 1 |
| 3-8 | 630313 | Ball | 1 |
| 3-9 | 803355 | Cylinder assembly | 1 |
| 3-10 | 702977 | Washer | 2 |
| 3-11 | 632754 | Spring pin | 1 |
| 3-12 | 706072 | Foot tube | 1 |
| 3-13 | 702980 | Valve ring | 1 |
| 3-14 | 706399 | Plunger rod | 1 |
| 3-15 | 771404 | Foot valve | 1 |
| 3-16 | 702982 | Valve seat | 1 |
| 3-17 | 830407 | Valve adapter assembly | 1 |
| 3-18 | 702983 | Tube | 1 |
| 3-19 | 702984 | Plate | 1 |
| 3-20 | 627010 | Nut | 1 |
| 3-21 | 632019 | Cotter pin | 1 |
| 4 | 770409 | Packing | 1 |
| 5 | 711650 | Out tube | 1 |

6.3 802630 Air motor

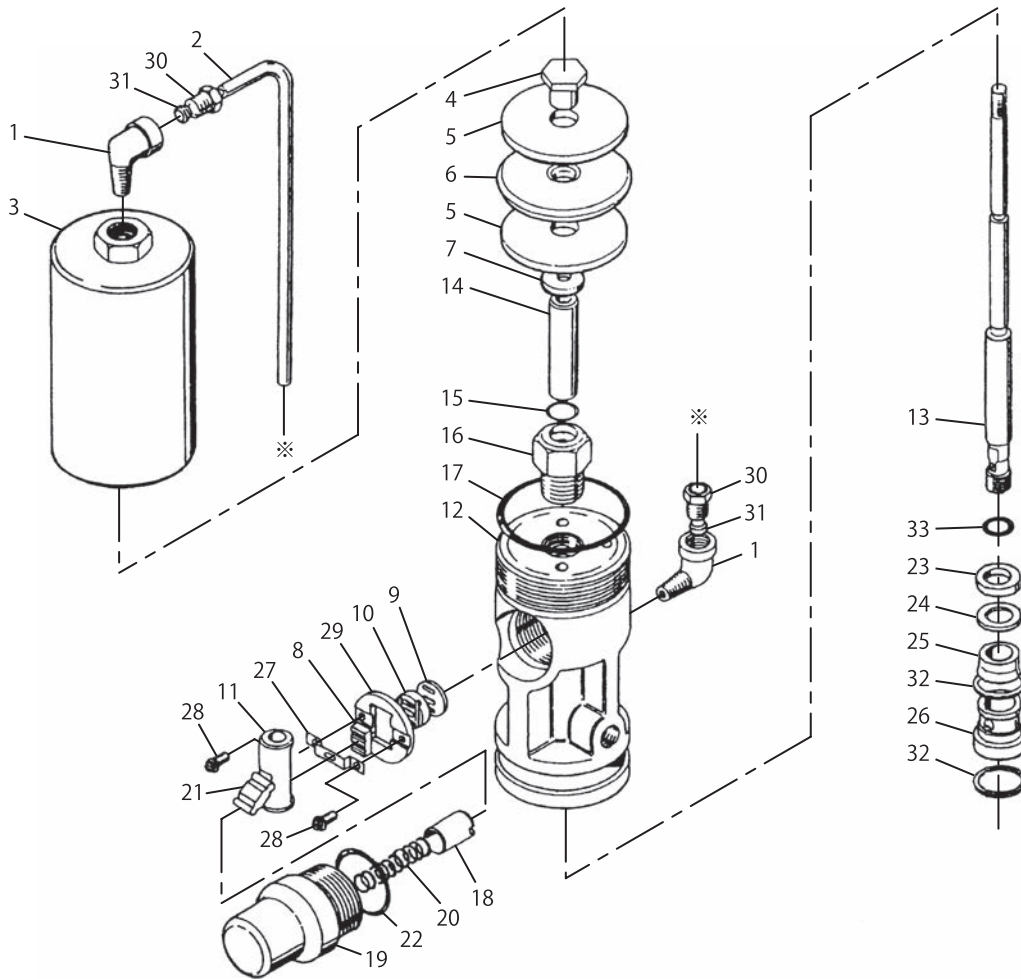

■ Parts List

| NO. | PARTS NO. | DESCRIPTION | QTY | NO. | PARTS NO. | DESCRIPTION | QTY |
|-----|-----------|---------------|-----|-----|-----------|------------------|-----|
| 1 | 701768 | Elbow | 2 | 18 | 704893 | Spring holder | 1 |
| 2 | 708523 | Pipe | 1 | 19 | 710672 | Cap | 1 |
| 3 | 708311 | Bonnet | 1 | 20 | 701825 | Spring | 1 |
| 4 | 701811 | Cap nut | 1 | 21 | 705661 | Trip shoe guide | 1 |
| 5 | 701815 | Washer | 1 | 22 | 682976 | O ring | 1 |
| 6 | 770180 | Packing | 2 | 23 | 710949 | Washer | 1 |
| 7 | 701810 | Washer | 1 | 24 | 771405 | Back up ring | 1 |
| 8 | 701823 | Block | 1 | 25 | 771418 | Packing | 1 |
| 9 | 770181 | Packing | 1 | 26 | 711384 | Collar | 1 |
| 10 | 701822 | Valve seat | 1 | 27 | 701816 | Valve supporter | 1 |
| 11 | 705659 | Trip shoe | 1 | 28 | 681768 | Screw (w/spring) | 2 |
| 12 | 710950 | Body | 1 | 29 | 590085 | Guide plate | 1 |
| 13 | 706068 | Spindle | 1 | 30 | 701766 | Tube gland | 2 |
| 14 | 706067 | Bushing | 1 | 31 | 701765 | Sleeve | 2 |
| 15 | 640012 | O ring | 1 | 32 | 702582 | Washer | 2 |
| 16 | 706066 | Gland housing | 1 | 33 | 683629 | O ring | 1 |
| 17 | 770182 | O ring | 1 | | | | |

<NOTE>

- If disassembly is required, ask the dealer to disassemble the air motor.
- As for the specialist of the dissolution, refer to the instruction manual.
(Separately APP006U: Instruction for Grease Pump)

6.4 851985 Grease gun

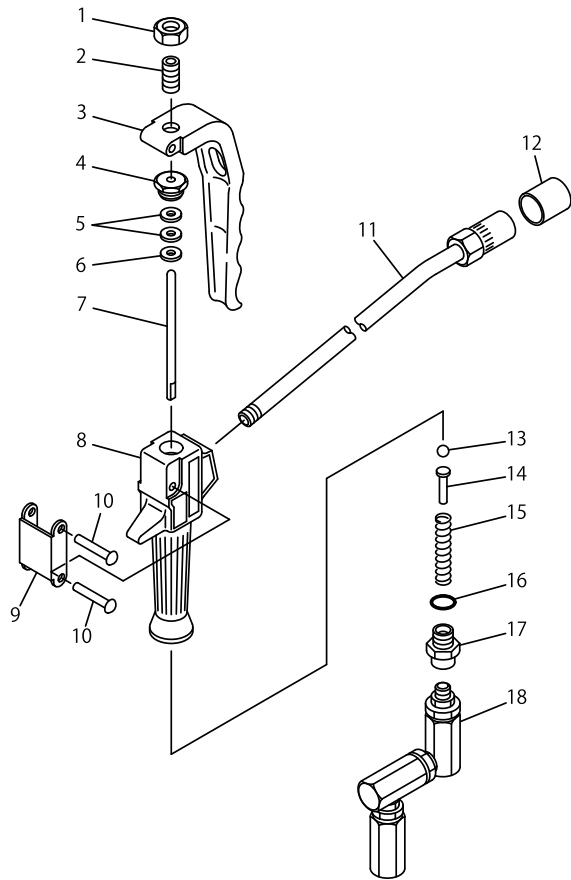

■ Parts List

| NO. | PARTS NO. | DESCRIPTION | QTY |
|-----|-----------|-----------------------|-----|
| 1 | 627641 | Nut | 1 |
| 2 | 711750 | Bolt | 1 |
| 3 | 711354 | Lever | 1 |
| 4 | 711444 | Retaining nut | 1 |
| 5 | 772160 | Packing | 2 |
| 6 | 713638 | Washer | 1 |
| 7 | 711357 | Rod | 1 |
| 8 | 711352 | Body | 1 |
| 9 | 711351 | Link | 1 |
| 10 | 683201 | Rivet | 2 |
| 11 | 804911 | Nozzle | 1 |
| 12 | 685728 | Cap | 1 |
| 13 | 630314 | Ball | 1 |
| 14 | 711445 | Spring retainer | 1 |
| 15 | 711446 | Spring | 1 |
| 16 | 640011 | O ring | 1 |
| 17 | 710971 | Union | 1 |
| 18 | 802910 | Swivel joint assembly | 1 |

★No.3, 8, 9 and No.10 are undissolution.

7. Specification

■ Engineering Data

| | | |
|-------------------------|------------------------------------|--|
| TYPE | | SKR-55EX |
| MODEL No. | | 881190 |
| PUMP RATIO (NOMINAL) | | 55 x 1 |
| MATERIAL CONNECTION | DISCHARGE PORT | High Pressure Grease Gun |
| AIR CONNECTION | SUPPLY PORT | Coupler Plug PS-20PM |
| OPERATING AIR PRESSURE | | 0.2 ~ 0.7 MPa |
| MAXIMUM OPERATING NOISE | A-WEIGHTED SOUND PRESSURE LEVEL *1 | 86 dB |
| | A-WEIGHTED SOUND POWER LEVEL *2 | 96 dB |
| AMB. TEMP. RANGE | ENV. TEMPERATURE | 0 ~ 60 °C |
| | MATERIAL TEMP. | 0 ~ 80 °C |
| WEIGHT | | 13.1 kg |
| ACCESSORIES | | 695034 High Pressure Hose 1/4 x 2.5m 851985 High Pressure Grease Gun 680743 Air Coupler(PS-20PM) |

*1 Measurement method of A-weighted sound pressure level is based on ISO 1996.

*2 Measurement method of A-weighted sound power level is based on ISO 3744.

■ Performance Curve(only the pump)

NOTE

The continuous pump operation should be avoided if the desired delivery is in the range shaded in the figure below.

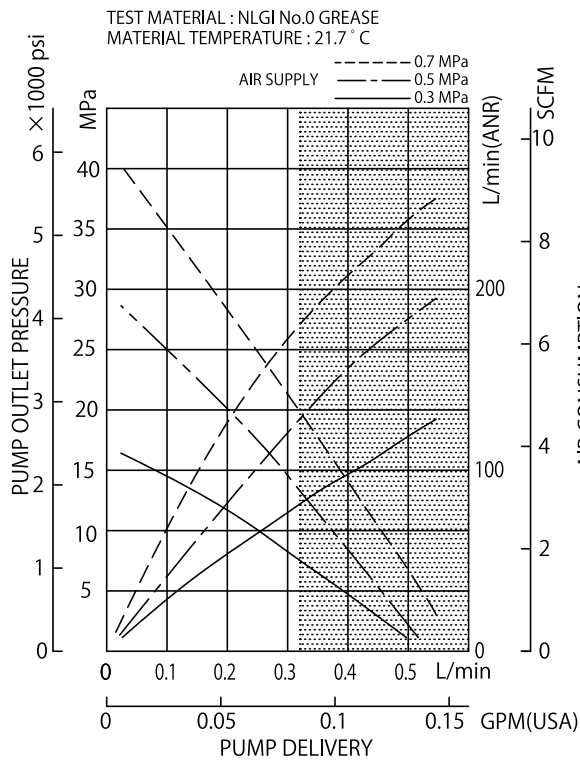

■ Dimensions

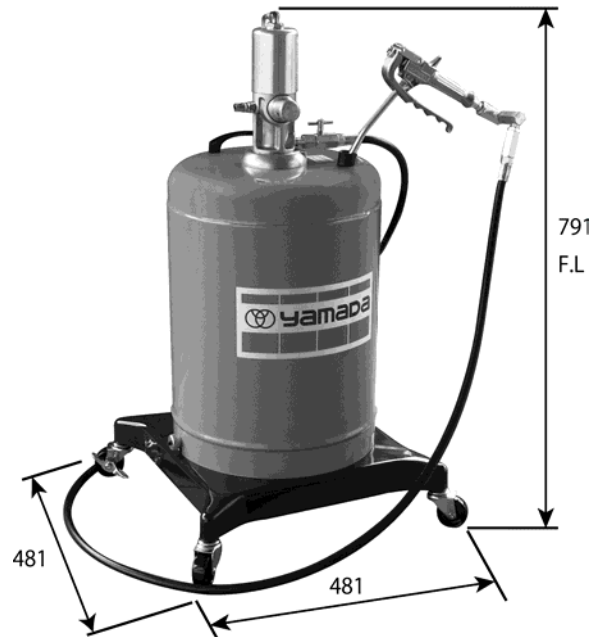

8. Limited Warranty

If an abnormality occurs during normal operation in accordance with the operating instructions and other operating cautions within the warranty period (12 months after date of purchase) that can be attributed to a manufacturing defect, the defective parts of this product will be serviced or the product will be replaced free of charge. However, this warranty will not cover compensation for incidental damage or any malfunction listed below.

1. Warranty period

This warranty will be valid for a period of 12 months after the date of purchase.

2. Warranty

If, during the warranty period, any of the material of the genuine parts of this product or the workmanship of this product is found defective, and is so verified by our company, the servicing cost will be fully born by our company.

3. Exclusion

Even during the warranty period, this warranty does not cover the following.

- 1) Malfunction arising from use of parts other than manufacturer-specified genuine parts
- 2) Malfunction arising from misuse or operating errors, or lack of storage or maintenance care
- 3) Malfunction arising from use with a fluid that may cause corrosion, inflation or dissolution of the component parts of the product
- 4) Irregularity arising from repair made by other than by our firm, our regional office, dealer or authorized service personnel
- 5) Malfunction arising from modification of the product by other than authorized service personnel
- 6) Wear and tear of parts that must be regularly replaced in the course of normal operation, such as packings, O-rings and hose.
- 7) Malfunction and/or damage due to use with incorrect voltage.
- 8) Malfunction and/or damage due to transportation, moving or drop page of the product after purchase
- 9) Malfunction and/or damage due to fire, earthquake, flood or other force majeure
- 10) Malfunction arising from use of compressed air that contains impurities or excessive moisture, or use of gases or fluids other than the specified compressed air
- 11) Malfunction arising from use of excessively abrasive material or of inadequate grease.

Furthermore, this warranty does not cover the rubber parts, or other parts used in this product and its accessories, which are subject to wear in normal operation.

- hoses
- packings
- cords

4. Parts

Parts for this product will be kept available for 5 years after discontinuation of production. Once 5 years have elapsed after close of production, availability of parts for this product cannot be guaranteed.

MEMO.

Manufactured by

YAMADA CORPORATION

INTERNATIONAL DEPARTMENT

No.1-3, 1-Chome, Minami-Magome, Ohta-Ku, Tokyo, 143-8504, Japan

PHONE : +81-(0)3-3777-0241

FAX : +81-(0)3-3777-0584

201705 OSA103U